

**KSP 110 – kryt sloupku plotu**

**KSP 110**

KRYT SLOUPKU PLOTU - hPVC

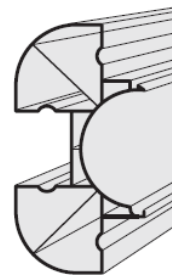

**DPP 100 – deska plotového  
pole 100 x 30mm - hPVC**

**DPP 100**

DESKA PLOTOVÉHO POLE 100 x 300 mm - hPVC

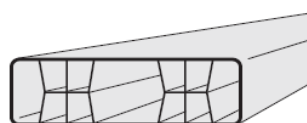

**KDL 30 – krycí a distanční  
lišta – hPVC**

**KDL 30**

KRYCÍ A DISTANČNÍ LIŠTA - hPVC

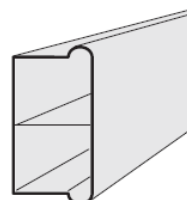

**DPP 70 – deska plotového  
pole 70 x 22mm - hPVC**

**DPP 70**

DESKA PLOTOVÉHO POLE 70 x 22 mm - hPVC

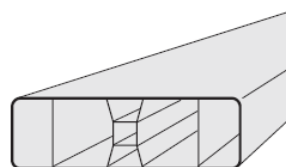

**1 ½ “ tl. 2 nebo 3 mm – ocel.  
trubka pro jádro sloupku  
– nedodává PP-Plastové ploty**

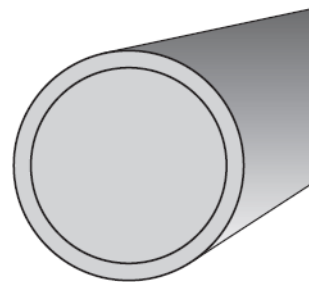

**25x25x2 mm ocel. profily jako  
možná výztuha desek plotového  
pole – nedodává PP-Plastové ploty**

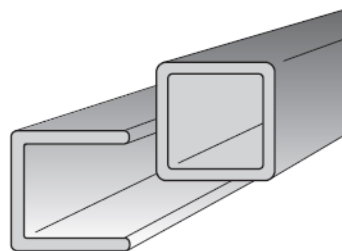

**VPK 110 – víko plastového krytu  
sloupku 110x110 mm – hPVC**

**VPK 110**

VÍKO PLASTOVÉHO KRYTU SLOUPKU 110x110 mm - hPVC

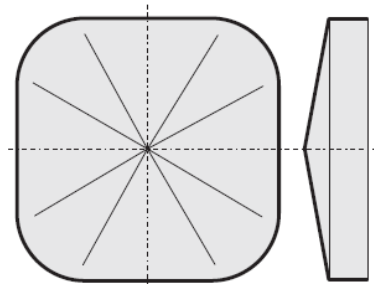

**KV 70 – krycí víčko pro desku  
DPP 70 - hPVC**

**KV 70**

KRYCÍ VÍČKO PRO DESKU DPP 70 -hPVC

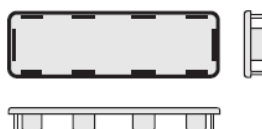

**SE 10 – spojovací element**

**SE 10**

SPOJOVACÍ ELEMENT

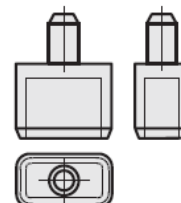

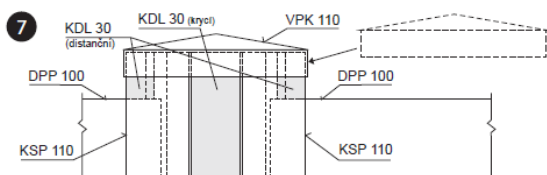
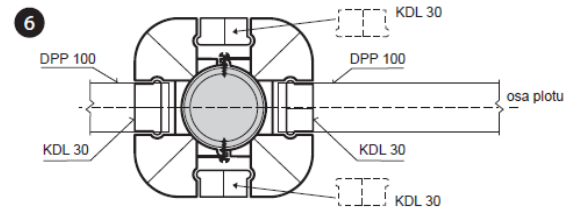
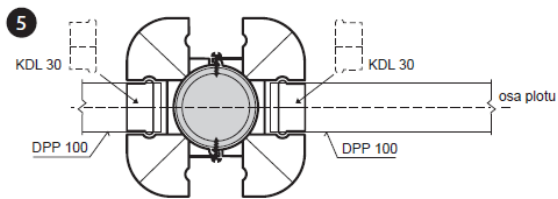
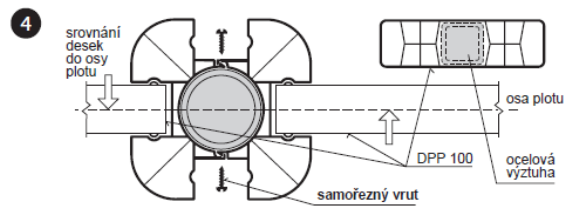
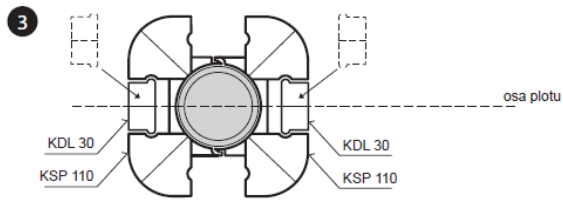
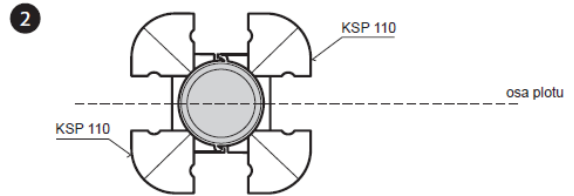
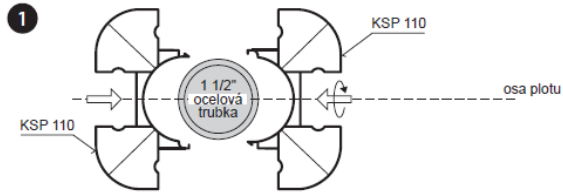

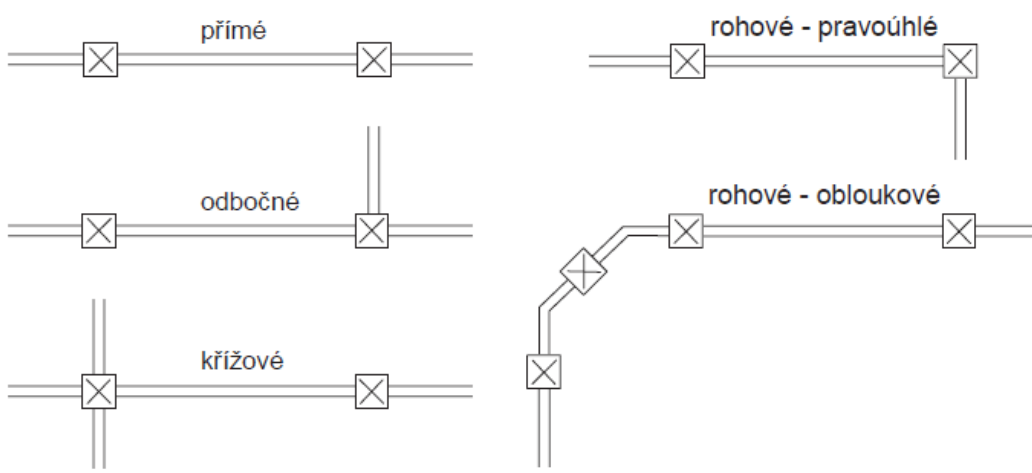
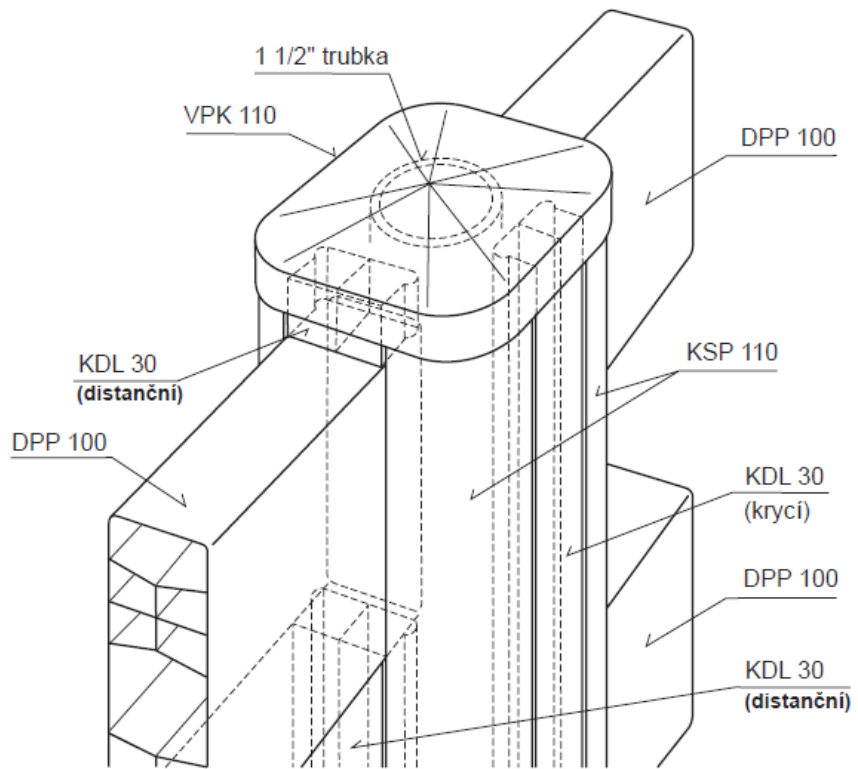

**A** HORIZONTAL

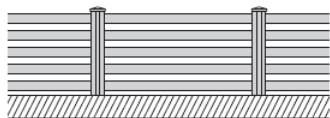

**B** PLNÁ STĚNA

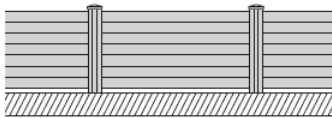

**C** KOMBI

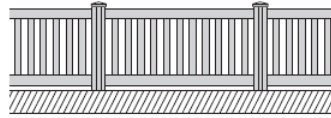

**D** VERTIKAL

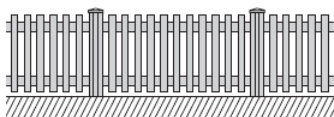

**E** HORNÍ OBLOUK

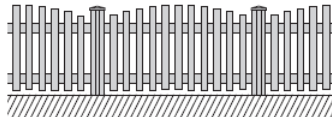

**F** SPODNÍ OBLOUK

